

# MGA-31389

0.1W High Gain Driver Amplifier

50MHz ~ 2GHz



## Data Sheet

### Description

Avago Technologies MGA-31389 is a high performance Driver Amplifier MMIC, housed in a standard SOT-89 plastic package. The device features flat high gain with excellent input and output return loss, as well as superior linearity performance. The device can be easily matched to obtain desired performance.

MGA-31389 is especially ideal for 50 Ω wireless infrastructure application within the 50 MHz to 2GHz frequency range applications. With high IP3 and low noise figure and wideband operation, the MGA-31389 may be utilized as a driver amplifier in the transmit chain and as a second stage LNA in the receiver chain.

This device uses Avago Technologies proprietary 0.25 μm GaAs Enhancement mode PHEMT process.

### Pin connections and Package Marking

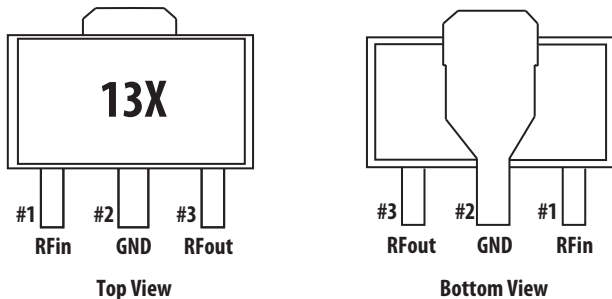

Note:

Package marking provides orientation and identification

"13" = Device Code

"X" = Date Code character identifies month of manufacturing



**Attention: Observe precautions for handling electrostatic sensitive devices.**  
ESD Machine Model = 75 V  
ESD Human Body Model = 1000 V  
Refer to Avago Application Note A004R:  
Electrostatic Discharge, Damage and Control.

### Features

- ROHS compliant
- Halogen free
- High IP3 at low DC bias power<sup>(1)</sup>
- High gain, with good gain flatness
- Low noise figure
- Advanced enhancement mode PHEMT Technology
- Excellent uniformity in product specification
- SOT-89 standard package

### Specifications

At 0.9 GHz, Vd = 5 V, Id = 73 mA (typ) @ 25° C

- OIP3 = 38.6 dBm
- Noise Figure = 2.0 dB
- Gain = 21.3 dB, Gain flatness (± 50 MHz) = 0.14 dB
- P1dB = 22.2 dBm
- IRL = 30.5 dB, ORL = 14.7 dB

Note:

1. The MGA-31389 has a superior LFOM of 13.3 dB. Linearity Figure of Merit (LFOM) is essentially OIP3 divided by DC bias power.

### Simplified Schematic

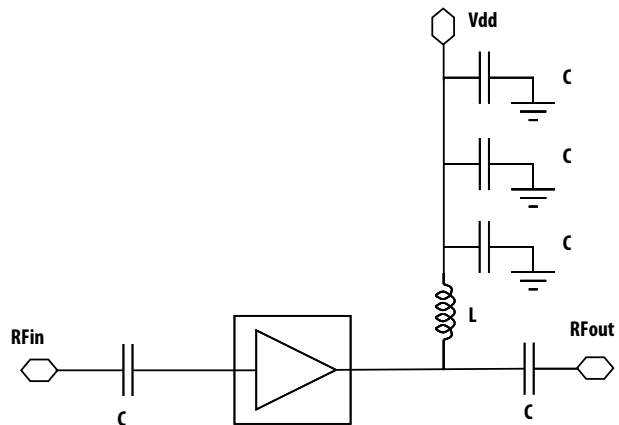

Figure 1. Simplified Schematic diagram

### MGA-31389 Absolute Maximum Rating <sup>(1)</sup> T<sub>A</sub>=25° C

| Symbol              | Parameter                          | Units | Absolute Max. |
|---------------------|------------------------------------|-------|---------------|
| V <sub>d, max</sub> | Drain Voltage, RF output to ground | V     | 5.5           |
| P <sub>d</sub>      | Power Dissipation <sup>(2)</sup>   | mW    | 605           |
| P <sub>in</sub>     | CW RF Input Power                  | dBm   | 20            |
| T <sub>j</sub>      | Junction Temperature               | °C    | 150           |
| T <sub>STG</sub>    | Storage Temperature                | °C    | -65 to 150    |

### Thermal Resistance

#### Thermal Resistance <sup>(3)</sup>

(V<sub>d</sub> = 5.0 V, T<sub>c</sub> = 85° C, θ<sub>jc</sub> = 60.0° C/W)

Notes:

1. Operation of this device in excess of any of these limits may cause permanent damage.
2. Source lead temperature is 25° C. Derate 16.7 mW/° C for T<sub>L</sub>>128.0° C.
3. Thermal resistance measured using 150° C Infra-Red Microscopy Technique.

### MGA-31389 Electrical Specification <sup>(1)</sup>

T<sub>C</sub> = 25° C, V<sub>d</sub> = 5 V, unless noted

| Symbol              | Parameter and Test Condition          | Frequency   | Units | Min. | Typ.                 | Max. |
|---------------------|---------------------------------------|---|-------|------|----------------------|------|
| I <sub>ds</sub>     | Quiescent Current                     | N/A   | mA    | 62   | 73                   | 90   |
| NF                  | Noise Figure                          | 0.45 GHz<br>0.9 GHz<br>1.5 GHz  | dB    | -    | 2.3<br>2.0<br>2.0    | 2.5  |
| Gain                | Gain                                  | 0.45 GHz<br>0.9 GHz<br>1.5 GHz  | dB    | 20   | 21.5<br>21.3<br>20.6 | 23   |
| OIP3 <sup>(2)</sup> | Output Third Order Intercept Point    | 0.45 GHz <sup>(2)</sup><br>0.9 GHz <sup>(2)</sup><br>1.5 GHz <sup>(2)</sup> | dBm   | 36.3 | 38.6<br>38.6<br>41.3 | -    |
| P1dB                | Output Power at 1 dB Gain Compression | 0.45 GHz<br>0.9 GHz<br>1.5 GHz  | dBm   | 20.6 | 22.0<br>22.2<br>21.7 | -    |
| PAE                 | Power Added Efficiency at P1dB        | 0.45 GHz<br>0.9 GHz<br>1.5 GHz  | %     | -    | 41.0<br>41.2<br>38.4 | -    |
| IRL                 | Input Return Loss                     | 0.45 GHz<br>0.9 GHz<br>1.5 GHz  | dB    | -    | 24.3<br>30.5<br>15.3 | -    |
| ORL                 | Output Return Loss                    | 0.45 GHz<br>0.9 GHz<br>1.5 GHz  | dB    | -    | 11.4<br>14.7<br>12.1 | -    |
| ISOL                | Isolation                             | 0.45 GHz<br>0.9 GHz<br>1.5 GHz  | dB    | -    | 27.2<br>27.6<br>28.6 | -    |

Note :

1. Measurements obtained from a test circuit described in Figure 34
2. OIP3 test condition: F1 - F2 = 10 MHz, with input power of -14 dBm per tone measured at worst case side band.

## MGA-31389 Consistency Distribution Chart (1,2)

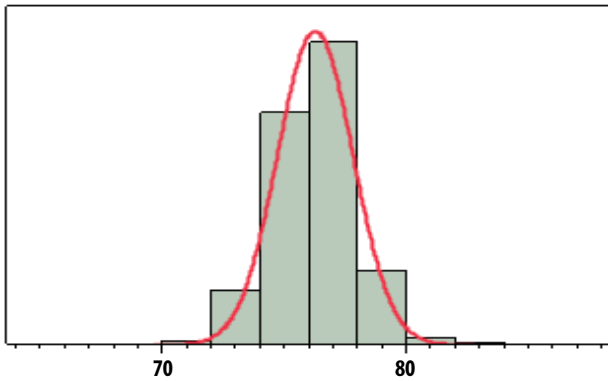

Figure 2. Id @ 900MHz, Vd=5V, LSL=62mA, Nominal=76mA, USL=90mA

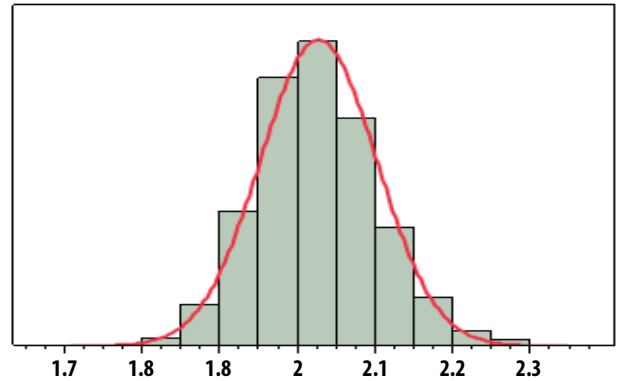

Figure 3. NF @ 900MHz, Vd=5V, Nominal=2.0dB, USL=2.5dB

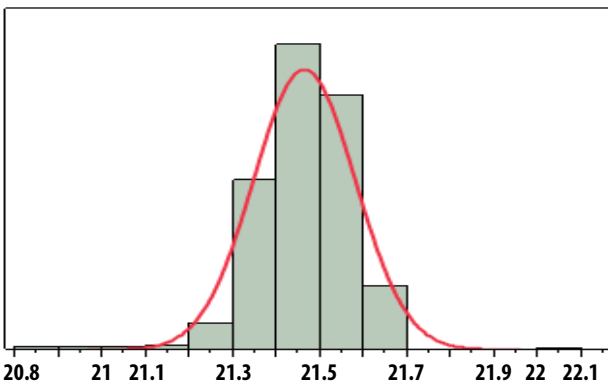

Figure 4. Gain @ 900MHz, Vd=5V, LSL=20dB, Nominal=21.5dB, USL=23dB

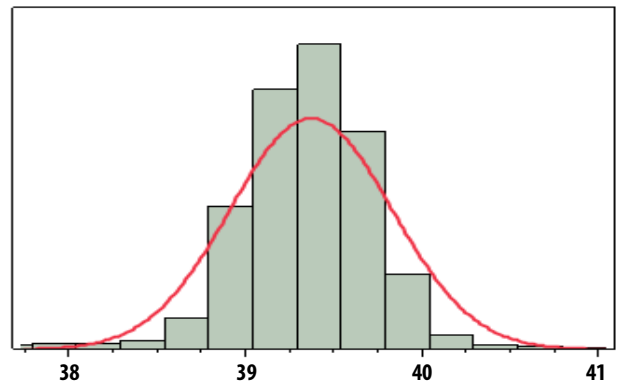

Figure 5. OIP3 @ 900MHz, Vd=5V, LSL=36.3dBm, Nominal=39.3dBm

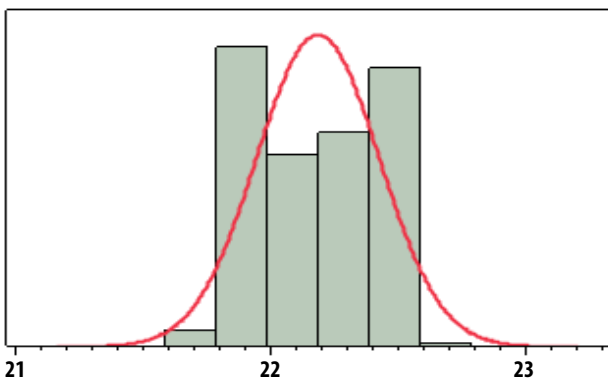

Figure 6. P1dB @ 900MHz, Vd=5V, LSL= 20.6dBm, Nominal=22.2dBm

### Notes:

1. Data sample size is 3000 samples taken from 3 different wafers and 2 different lots. Future wafers allocated to this product may have nominal values anywhere between the upper and lower limits.
2. Measurements are made on production test board which represents a trade-off between optimal Gain, NF, OIP3 and OP1dB. Circuit losses have been de-embedded from actual measurements.

# MGA-31389 Application Circuit Data for 450 MHz

$T_c = 25^\circ\text{C}$ ,  $V_d = 5.0\text{V}$ ,  $I_d = 73\text{mA}$

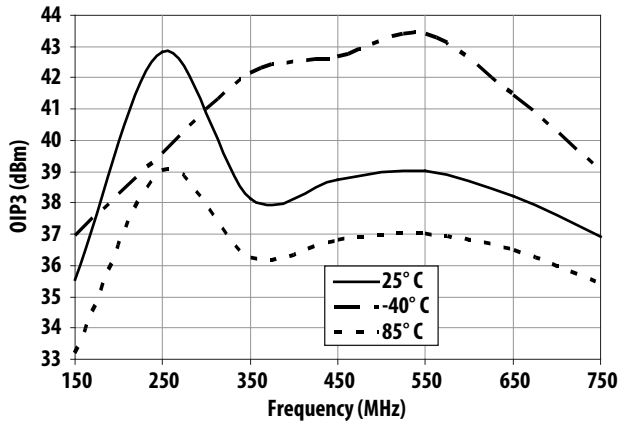

Figure 7. OIP3 vs Frequency and Temperature

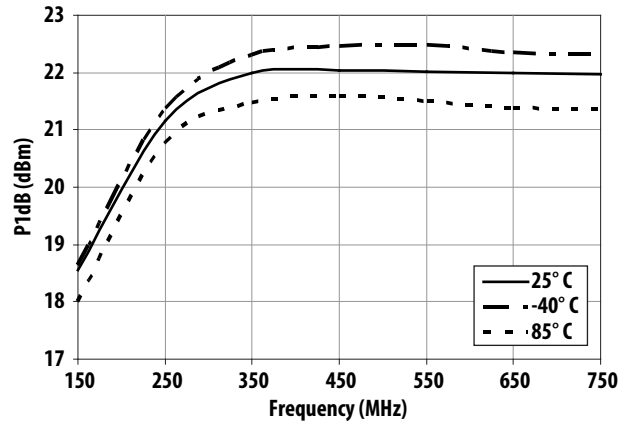

Figure 8. P1dB vs Frequency and Temperature

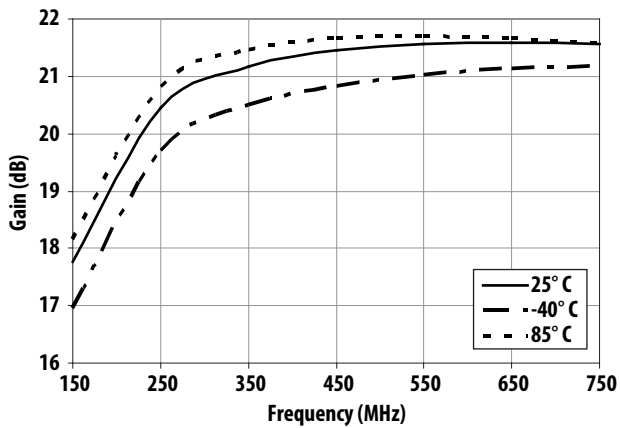

Figure 9. Gain vs Frequency and Temperature

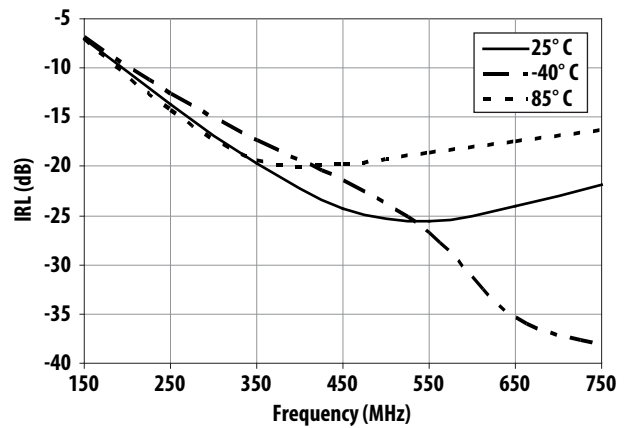

Figure 10. IRL vs Frequency and Temperature

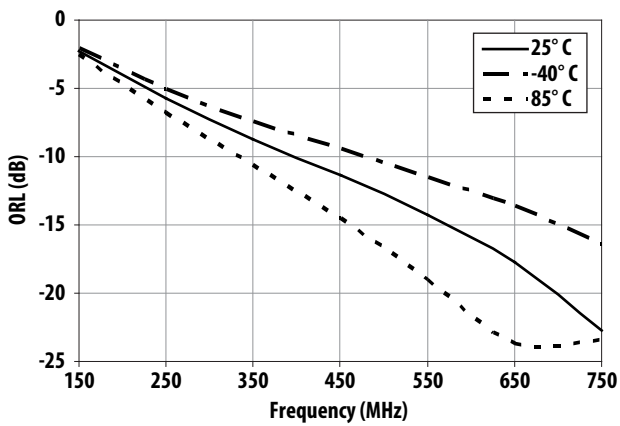

Figure 11. ORL vs Frequency and Temperature

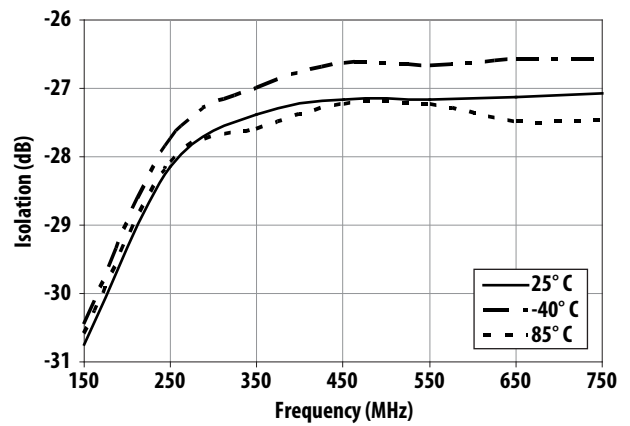

Figure 12. Isolation vs Frequency and Temperature

## MGA-31389 Application Circuit Data for 450 MHz (cont'd)

$T_c = 25^\circ\text{C}$ ,  $V_d = 5.0\text{ V}$ ,  $I_d = 73\text{ mA}$

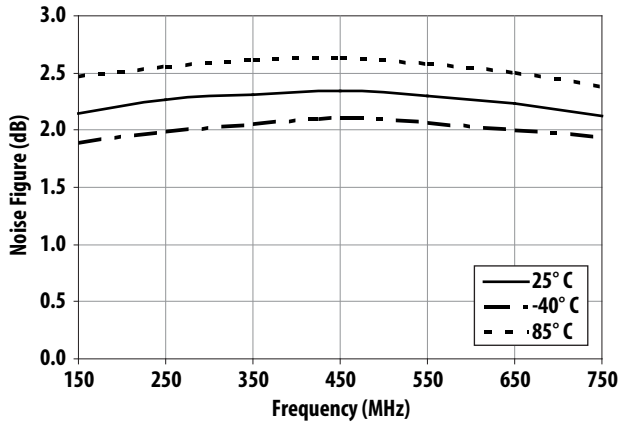

Figure 13. Noise Figure vs Frequency and Temperature

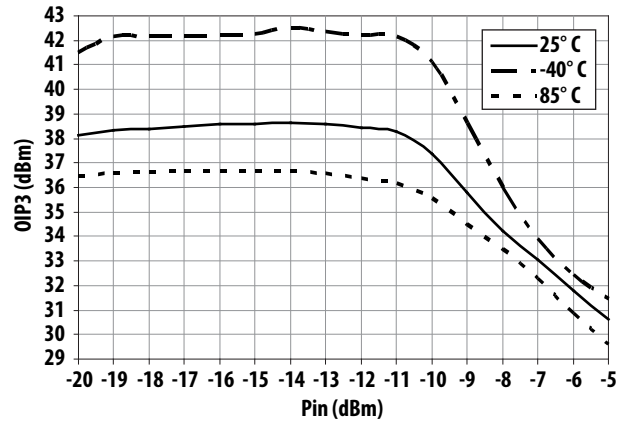

Figure 14. OIP3 vs Input Power and Temperature

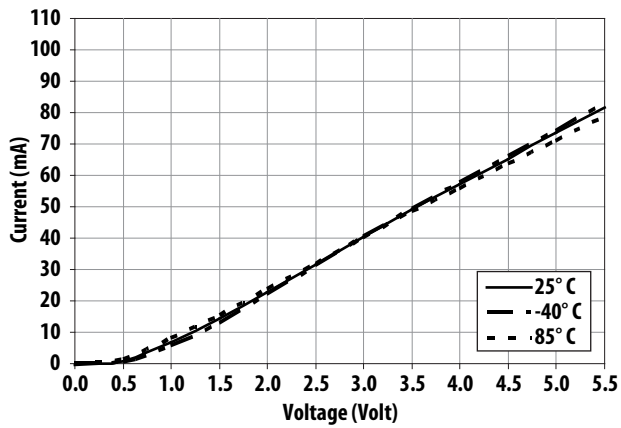

Figure 15. Current vs Voltage and Temperature

# MGA-31389 Application Circuit Data for 900 MHz

$T_c = 25^\circ\text{C}$ ,  $V_d = 5.0\text{V}$ ,  $I_d = 73\text{mA}$

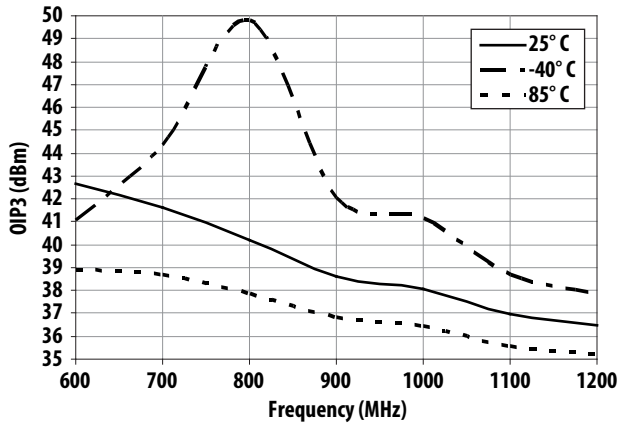

Figure 16. OIP3 vs Frequency and Temperature

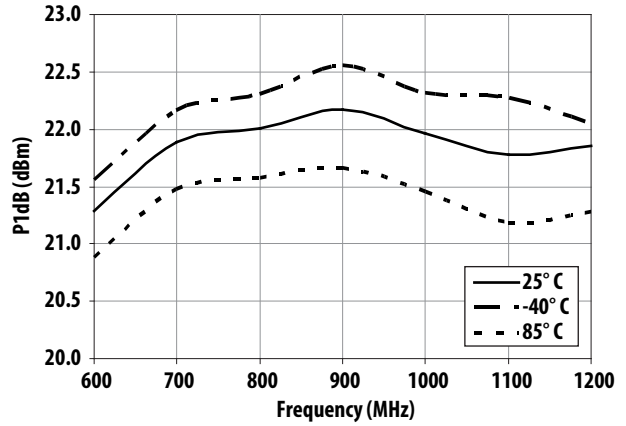

Figure 17. P1dB vs Frequency and Temperature

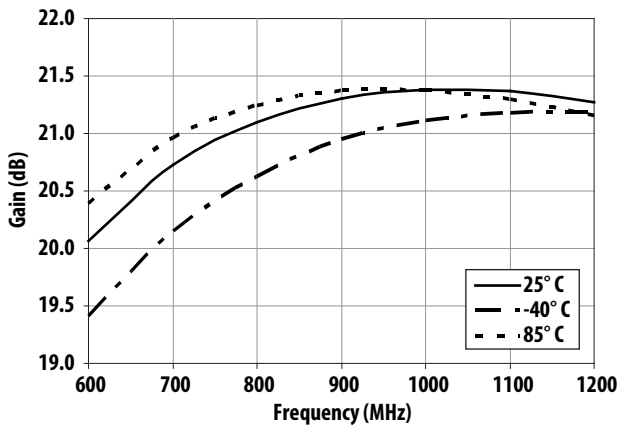

Figure 18. Gain vs Frequency and Temperature

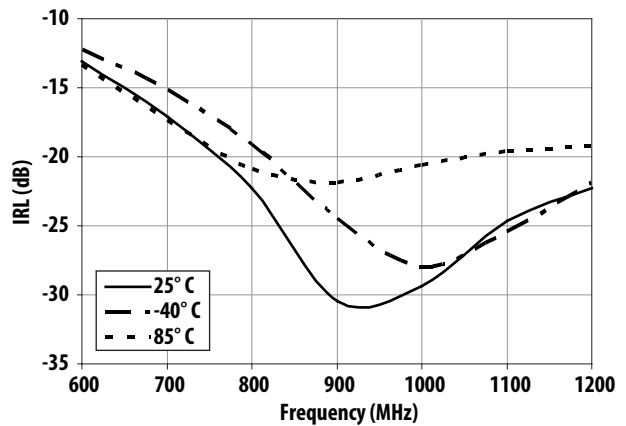

Figure 19. IRL vs Frequency and Temperature

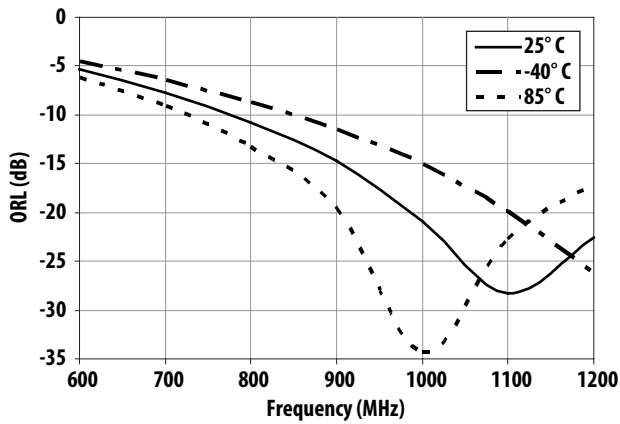

Figure 20. ORL vs Frequency and Temperature

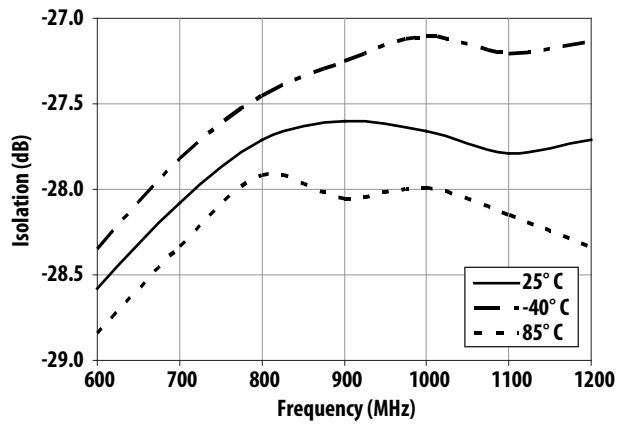

Figure 21. Isolation vs Frequency and Temperature

## MGA-31389 Application Circuit Data for 900 MHz (cont'd)

$T_c = 25^\circ\text{C}$ ,  $V_d = 5.0\text{ V}$ ,  $I_d = 73\text{ mA}$

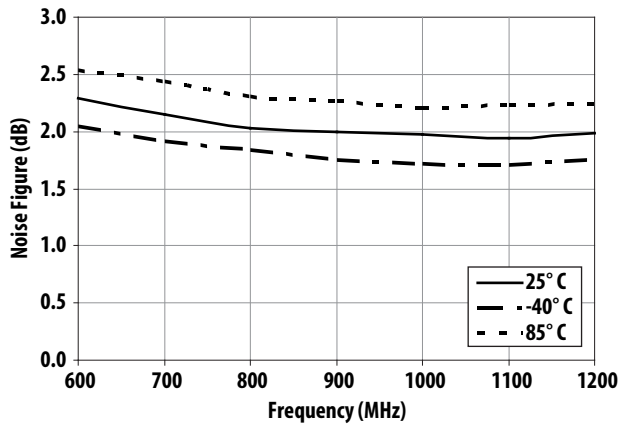

Figure 22. Noise Figure vs Frequency and Temperature

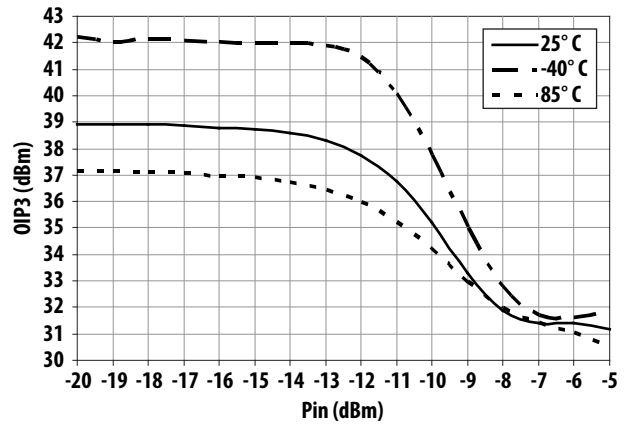

Figure 23. OIP3 vs Input Power and Temperature

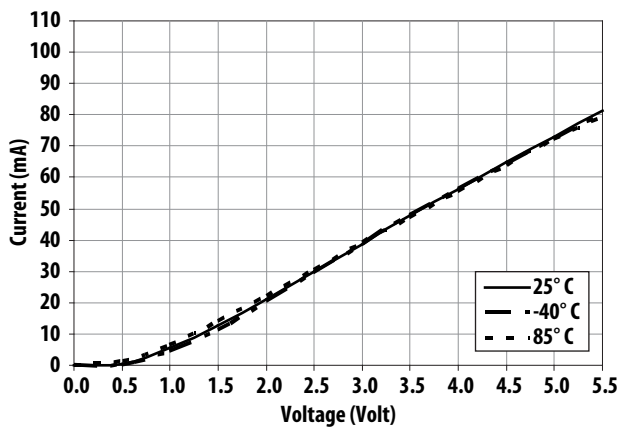

Figure 24. Current vs Voltage and Temperature

# MGA-31389 Application Circuit Data for 1500MHz

$T_c = 25^\circ\text{C}$ ,  $V_d = 5.0\text{V}$ ,  $I_d = 73\text{mA}$

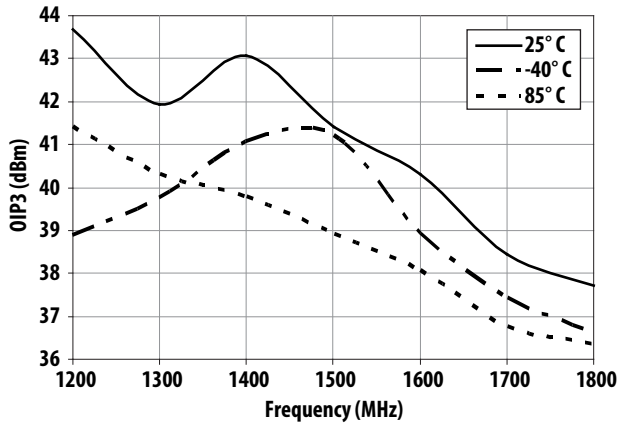

Figure 25. OIP3 vs Frequency and Temperature

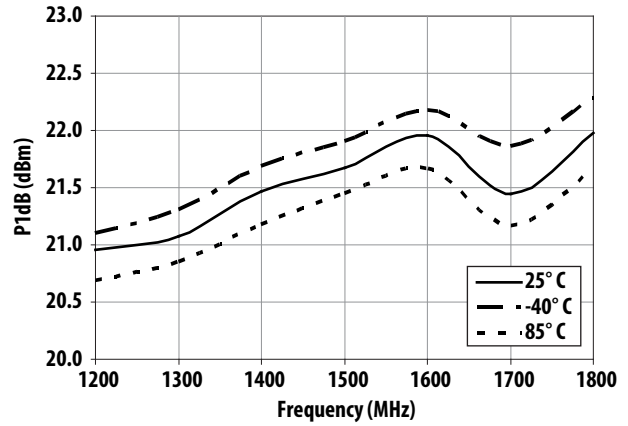

Figure 26. P1dB vs Frequency and Temperature

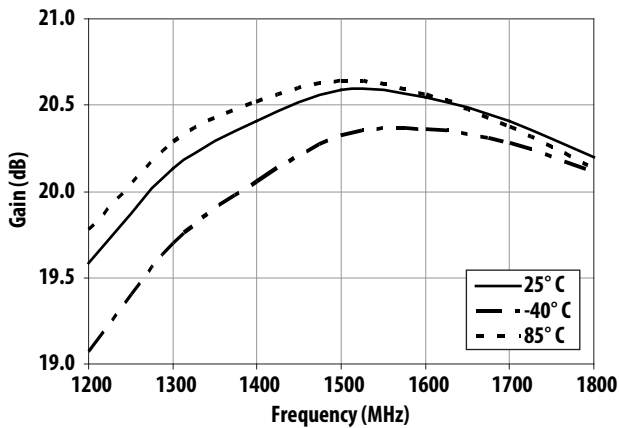

Figure 27. Gain vs Frequency and Temperature

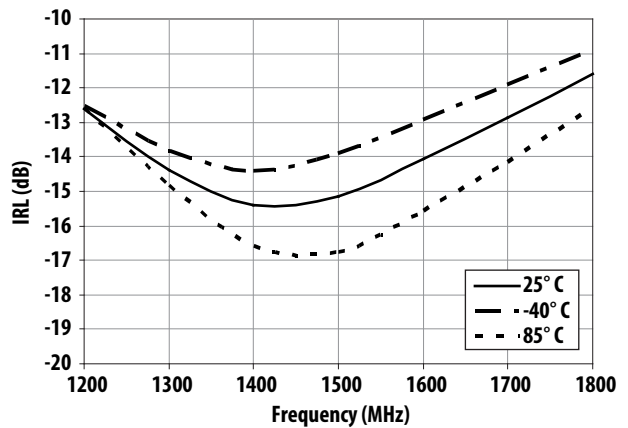

Figure 28. IRL vs Frequency and Temperature

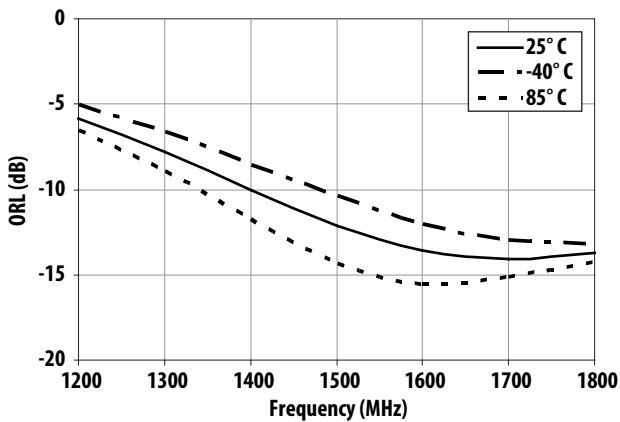

Figure 29. ORL vs Frequency and Temperature

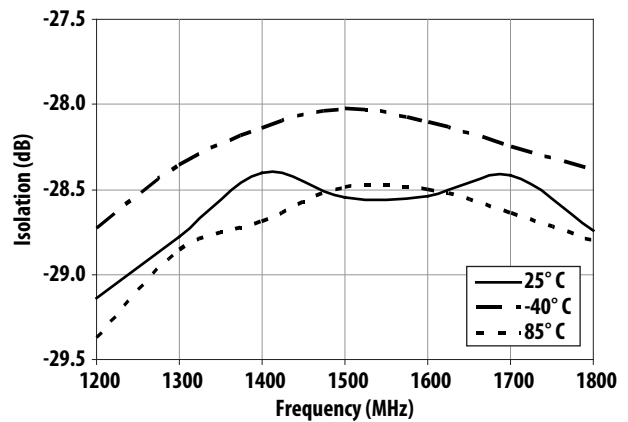

Figure 30. Isolation vs Frequency and Temperature



## MGA-31389 Application Circuit Data for 1500 MHz (cont'd)

$T_c = 25^\circ\text{C}$ ,  $V_d = 5.0\text{V}$ ,  $I_d = 73\text{mA}$

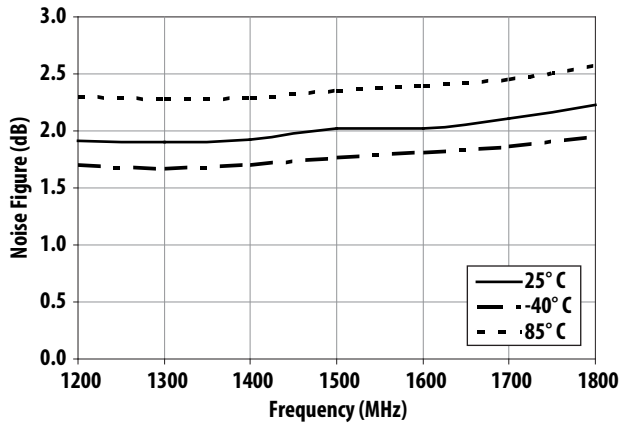

Figure 31. Noise Figure vs Frequency and Temperature

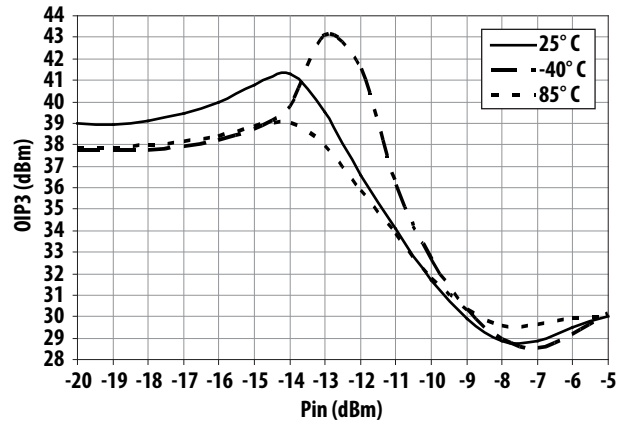

Figure 32. OIP3 vs Input Power and Temperature

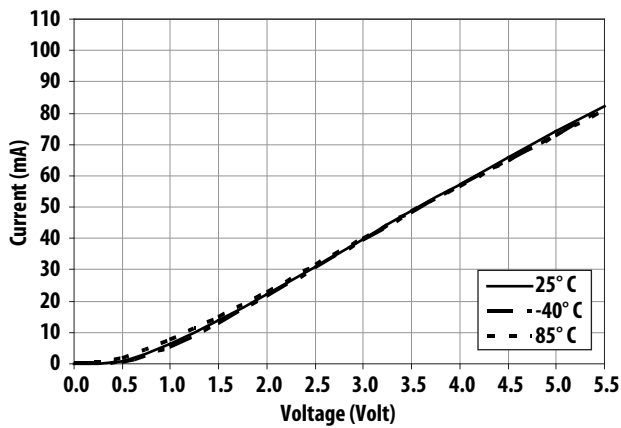

Figure 33. Current vs Voltage and Temperature

## Application Circuit Description and Layout

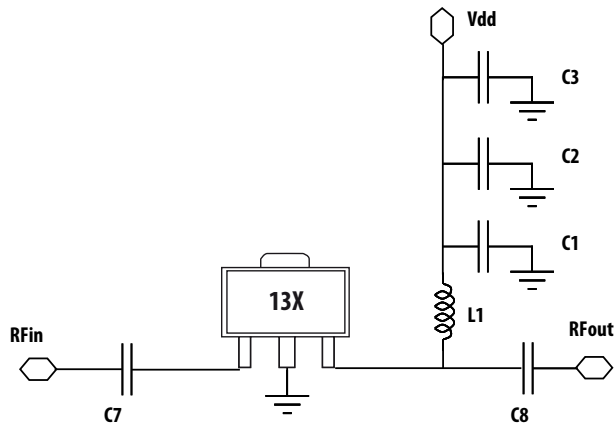

Figure 34. Circuit diagram

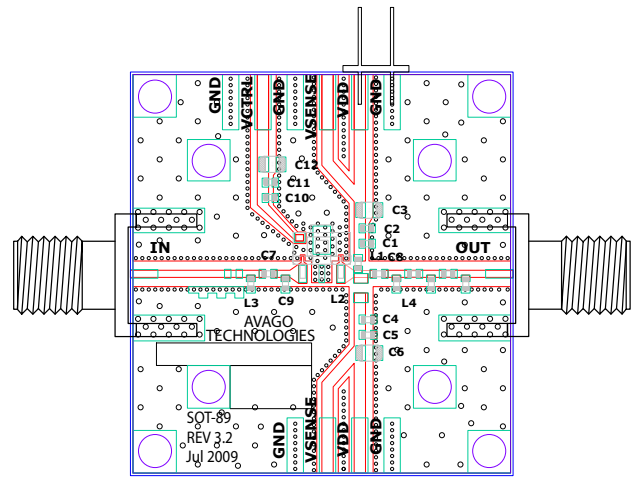

Figure 35. Demoboard

## Bill of Materials

| Circuit Symbol | Size | Description                 |              |                            |              |                            |              |
|----------------|------|-----------------------------|--------------|----------------------------|--------------|----------------------------|--------------|
|                |      | For 0.45 GHz <sup>(1)</sup> |              | For 0.9 GHz <sup>(2)</sup> |              | For 1.5 GHz <sup>(3)</sup> |              |
|                |      | Value                       | Manufacturer | Value                      | Manufacturer | Value                      | Manufacturer |
| C1             | 0402 | 10 pF                       | Murata       | 3.0 pF                     | Murata       | 3.9 pF                     | Murata       |
| C2             | 0402 | 0.1 μF                      | Murata       | 0.1 μF                     | Murata       | 0.1 μF                     | Murata       |
| C3             | 0603 | 2.2 μF                      | Murata       | 2.2 μF                     | Murata       | 2.2 μF                     | Murata       |
| C7             | 0402 | 100 pF                      | Murata       | 100 pF                     | Murata       | 100 pF                     | Murata       |
| C8             | 0402 | 15 pF                       | Murata       | 5.6 pF                     | Murata       | 3 pF                       | Murata       |
| L1             | 0402 | 39 nH                       | Murata       | 12 nH                      | Murata       | 3.9 nH                     | Murata       |

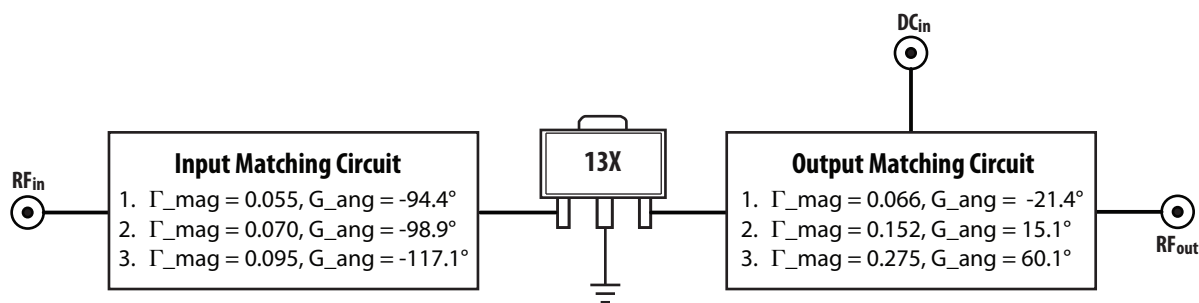

Figure 36. Input and output tuned Gamma location for 450MHz <sup>(1)</sup>, 900MHz <sup>(2)</sup> and 1500MHz <sup>(3)</sup>

For best performance, MGA-31389 is an input and output prematched driver amplifier. To bias MGA-31389, a +5V supply (Vdd) is connected to the output pin through a RF choke, L1 (which isolates the inband signal from the DC supply). The bypass capacitor helps to eliminate out of low band frequency signals from the power supply, C3, C2 and C1. Blocking capacitors are required for its input (C7) and output (C8), to isolate the supply voltage from preceding and succeeding circuits. C7 also plays a part in input tuning to improve input return loss while L1 and C8 help in tuning output. The recommended output tuning is for achieving best OIP3, while meeting typical specifications for other parameters.

### MGA-31389 Typical Scatter Parameters (1)

$T_c = 25^\circ\text{C}$ ,  $V_d = 5.0\text{V}$ ,  $I_d = 73\text{mA}$ ,  $Z_o = 50\ \Omega$

| Freq  | S11   | S11   | S11    | S21    | S21   | S21    | S12   | S12   | S12    | S22   | S22   | S22    | K Factor |
|-------|-------|-------|--------|--------|-------|--------|-------|-------|--------|-------|-------|--------|----------|
| GHz   | Mag.  | dB    | Ang.   | Mag.   | dB    | Ang.   | Mag.  | dB    | Ang.   | Mag.  | dB    | Ang.   |          |
| 0.10  | 0.046 | -26.7 | -127.5 | 12.372 | 21.8  | 169.8  | 0.046 | -26.8 | -3.3   | 0.281 | -11.0 | 172.9  | 1.100    |
| 0.20  | 0.034 | -29.4 | -146.1 | 12.409 | 21.9  | 162.4  | 0.046 | -26.7 | -9.9   | 0.270 | -11.4 | 160.6  | 1.104    |
| 0.30  | 0.032 | -29.9 | -150.7 | 12.415 | 21.9  | 154.2  | 0.046 | -26.7 | -15.9  | 0.258 | -11.8 | 149.5  | 1.108    |
| 0.40  | 0.035 | -29.0 | -146.0 | 12.406 | 21.9  | 145.8  | 0.046 | -26.8 | -21.9  | 0.240 | -12.4 | 138.9  | 1.117    |
| 0.50  | 0.040 | -27.9 | -138.6 | 12.386 | 21.9  | 137.2  | 0.046 | -26.8 | -27.8  | 0.216 | -13.3 | 128.8  | 1.130    |
| 0.60  | 0.047 | -26.5 | -135.8 | 12.350 | 21.8  | 128.6  | 0.045 | -26.9 | -33.7  | 0.189 | -14.5 | 118.3  | 1.143    |
| 0.70  | 0.053 | -25.5 | -137.3 | 12.308 | 21.8  | 119.8  | 0.045 | -27.0 | -39.6  | 0.161 | -15.9 | 107.3  | 1.158    |
| 0.80  | 0.057 | -24.8 | -141.8 | 12.247 | 21.8  | 111.1  | 0.044 | -27.0 | -45.6  | 0.133 | -17.5 | 95.1   | 1.174    |
| 0.90  | 0.059 | -24.5 | -149.0 | 12.179 | 21.7  | 102.2  | 0.044 | -27.2 | -51.5  | 0.106 | -19.5 | 81.1   | 1.192    |
| 1.00  | 0.058 | -24.8 | -158.8 | 12.092 | 21.7  | 93.4   | 0.043 | -27.3 | -57.6  | 0.081 | -21.8 | 63.4   | 1.211    |
| 1.10  | 0.051 | -25.8 | -168.3 | 12.003 | 21.6  | 84.5   | 0.043 | -27.4 | -63.3  | 0.067 | -23.5 | 39.1   | 1.230    |
| 1.20  | 0.042 | -27.6 | 170.5  | 11.913 | 21.5  | 75.4   | 0.042 | -27.5 | -69.2  | 0.054 | -25.3 | 10.9   | 1.248    |
| 1.30  | 0.035 | -29.1 | 131.7  | 11.805 | 21.4  | 66.2   | 0.041 | -27.7 | -75.2  | 0.049 | -26.3 | -21.3  | 1.266    |
| 1.40  | 0.042 | -27.5 | 83.8   | 11.686 | 21.4  | 56.9   | 0.041 | -27.8 | -81.2  | 0.052 | -25.7 | -53.4  | 1.282    |
| 1.50  | 0.067 | -23.5 | 50.5   | 11.545 | 21.2  | 47.4   | 0.040 | -27.9 | -87.4  | 0.060 | -24.4 | -78.5  | 1.298    |
| 1.60  | 0.102 | -19.9 | 28.8   | 11.382 | 21.1  | 37.7   | 0.040 | -28.0 | -93.6  | 0.070 | -23.1 | -98.5  | 1.311    |
| 1.70  | 0.143 | -16.9 | 12.1   | 11.165 | 21.0  | 27.8   | 0.039 | -28.2 | -100.3 | 0.080 | -22.0 | -114.8 | 1.324    |
| 1.80  | 0.189 | -14.5 | -2.8   | 10.908 | 20.8  | 17.9   | 0.039 | -28.3 | -107.1 | 0.089 | -21.0 | -128.9 | 1.335    |
| 1.90  | 0.240 | -12.4 | -16.6  | 10.600 | 20.5  | 7.7    | 0.038 | -28.4 | -114.4 | 0.096 | -20.3 | -141.7 | 1.348    |
| 2.00  | 0.292 | -10.7 | -30.0  | 10.230 | 20.2  | -2.5   | 0.037 | -28.6 | -121.8 | 0.102 | -19.8 | -153.3 | 1.364    |
| 2.10  | 0.346 | -9.2  | -43.5  | 9.831  | 19.9  | -12.8  | 0.036 | -28.8 | -129.5 | 0.107 | -19.4 | -164.5 | 1.384    |
| 2.20  | 0.398 | -8.0  | -56.6  | 9.365  | 19.4  | -23.1  | 0.035 | -29.1 | -137.6 | 0.108 | -19.3 | -175.7 | 1.411    |
| 2.30  | 0.450 | -6.9  | -69.7  | 8.862  | 19.0  | -33.4  | 0.034 | -29.4 | -145.7 | 0.107 | -19.4 | 174.4  | 1.447    |
| 2.40  | 0.501 | -6.0  | -82.4  | 8.323  | 18.4  | -43.6  | 0.033 | -29.7 | -154.1 | 0.104 | -19.7 | 165.1  | 1.489    |
| 2.50  | 0.549 | -5.2  | -94.7  | 7.764  | 17.8  | -53.5  | 0.031 | -30.1 | -162.4 | 0.098 | -20.1 | 156.7  | 1.546    |
| 3.00  | 0.744 | -2.6  | -148.3 | 5.017  | 14.0  | -99.1  | 0.023 | -32.8 | 157.6  | 0.040 | -27.9 | 148.5  | 1.973    |
| 3.50  | 0.853 | -1.4  | 174.9  | 3.042  | 9.7   | -135.2 | 0.017 | -35.6 | 124.7  | 0.089 | -21.0 | -133.1 | 2.645    |
| 4.00  | 0.900 | -0.9  | 150.2  | 1.908  | 5.6   | -163.5 | 0.014 | -37.2 | 98.7   | 0.195 | -14.2 | -142.0 | 3.446    |
| 5.00  | 0.908 | -0.8  | 105.9  | 0.945  | -0.5  | 147.1  | 0.014 | -37.2 | 55.9   | 0.328 | -9.7  | -167.2 | 6.072    |
| 6.00  | 0.903 | -0.9  | 41.9   | 0.502  | -6.0  | 91.2   | 0.016 | -36.0 | 9.0    | 0.340 | -9.4  | 156.6  | 10.230   |
| 7.00  | 0.943 | -0.5  | -1.6   | 0.240  | -12.4 | 42.9   | 0.015 | -36.5 | -28.8  | 0.431 | -7.3  | 112.4  | 12.763   |
| 8.00  | 0.958 | -0.4  | -16.7  | 0.131  | -17.7 | 5.7    | 0.014 | -37.1 | -55.2  | 0.509 | -5.9  | 71.7   | 16.973   |
| 9.00  | 0.938 | -0.6  | -38.6  | 0.082  | -21.8 | -33.5  | 0.013 | -37.9 | -83.4  | 0.546 | -5.3  | 29.8   | 40.810   |
| 10.00 | 0.941 | -0.5  | -75.0  | 0.045  | -26.9 | -76.8  | 0.009 | -41.2 | -117.9 | 0.610 | -4.3  | -16.1  | 92.313   |
| 11.00 | 0.961 | -0.3  | -101.8 | 0.020  | -33.8 | -108.6 | 0.003 | -49.3 | -143.7 | 0.740 | -2.6  | -49.3  | 245.787  |
| 12.00 | 0.974 | -0.2  | -116.2 | 0.009  | -41.4 | -122.2 | 0.000 | -68.3 | -14.2  | 0.824 | -1.7  | -66.2  | 2552.738 |
| 13.00 | 0.969 | -0.3  | -127.3 | 0.004  | -49.0 | -108.5 | 0.003 | -49.4 | -6.7   | 0.839 | -1.5  | -85.5  | 746.065  |
| 14.00 | 0.951 | -0.4  | -145.5 | 0.004  | -48.2 | -63.1  | 0.006 | -43.8 | -28.7  | 0.836 | -1.6  | -115.5 | 573.063  |
| 15.00 | 0.956 | -0.4  | -168.7 | 0.006  | -44.3 | -70.1  | 0.008 | -41.9 | -57.1  | 0.871 | -1.2  | -144.7 | 211.605  |
| 16.00 | 0.966 | -0.3  | 178.6  | 0.006  | -45.1 | -101.7 | 0.007 | -43.5 | -89.3  | 0.910 | -0.8  | -158.6 | 153.352  |
| 17.00 | 0.966 | -0.3  | 171.8  | 0.002  | -53.8 | -69.5  | 0.003 | -49.9 | -64.3  | 0.924 | -0.7  | -162.9 | 749.036  |
| 18.00 | 0.949 | -0.5  | 158.3  | 0.004  | -49.1 | -14.3  | 0.004 | -47.2 | -27.6  | 0.906 | -0.9  | -170.2 | 587.481  |
| 19.00 | 0.946 | -0.5  | 139.4  | 0.007  | -42.5 | -13.5  | 0.008 | -42.1 | -21.2  | 0.852 | -1.4  | 171.1  | 244.925  |
| 20.00 | 0.947 | -0.5  | 125.2  | 0.012  | -38.7 | -17.0  | 0.012 | -38.7 | -21.6  | 0.822 | -1.7  | 145.1  | 122.769  |

### MGA-31389 K-Factor (1)

$T_c = 25^\circ\text{C}$ ,  $V_d = 5.0\text{ V}$ ,  $I_d = 73\text{ mA}$ ,  $Z_o = 50\ \Omega$

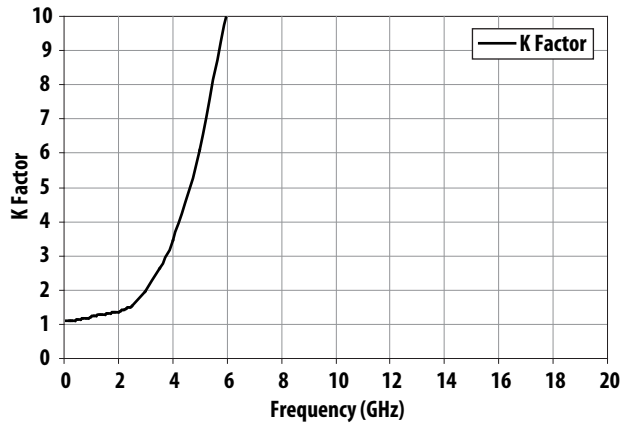

### MGA-31389 Typical Noise Parameters (1)

$T_c = 25^\circ\text{C}$ ,  $V_d = 5.0\text{ V}$ ,  $I_d = 73\text{ mA}$ ,  $Z_o = 50\ \Omega$

| Freq (GHz) | $F_{min}$ (dB) | $\Gamma_{opt}$ Mag | $\Gamma_{opt}$ Ang | $R_n/Z_o$ | Ga (dB) |
|------------|----------------|--------------------|--------------------|-----------|---------|
| 0.5        | 2.08           | 0.204              | 4.8                | 0.34      | 22.11   |
| 0.8        | 1.85           | 0.247              | 20.6               | 0.33      | 21.73   |
| 0.9        | 1.71           | 0.312              | 6.2                | 0.36      | 21.44   |
| 1          | 1.75           | 0.309              | 18.7               | 0.36      | 21.38   |
| 1.5        | 1.90           | 0.264              | 20.6               | 0.31      | 21.06   |
| 2          | 2.24           | 0.254              | 90.3               | 0.28      | 20.27   |
| 2.5        | 2.35           | 0.470              | 118.8              | 0.28      | 18.99   |
| 3          | 2.88           | 0.601              | 157.6              | 0.13      | 16.91   |
| 3.5        | 3.53           | 0.714              | -173.1             | 0.08      | 14.77   |
| 4          | 5.03           | 0.769              | -148.1             | 0.49      | 12.19   |
| 4.5        | 7.91           | 0.855              | -124.3             | 3.88      | 10.11   |
| 5          | 7.65           | 0.883              | -103.0             | 7.78      | 7.38    |
| 5.5        | 8.82           | 0.868              | -80.5              | 18.35     | 4.51    |
| 6          | 10.27          | 0.929              | -56.6              | 41.09     | 2.21    |

Note:

1. Measurements are made using 10 mils Rogers RO4350 TRL Board.

## Part Number Ordering Information

| Part Number    | No. of Devices | Container     |
|----------------|----------------|---------------|
| MGA-31389-BLKG | 100            | 7" Tape/Reel  |
| MGA-31389-TR1G | 3000           | 13" Tape/Reel |

## SOT89 Package Dimensions

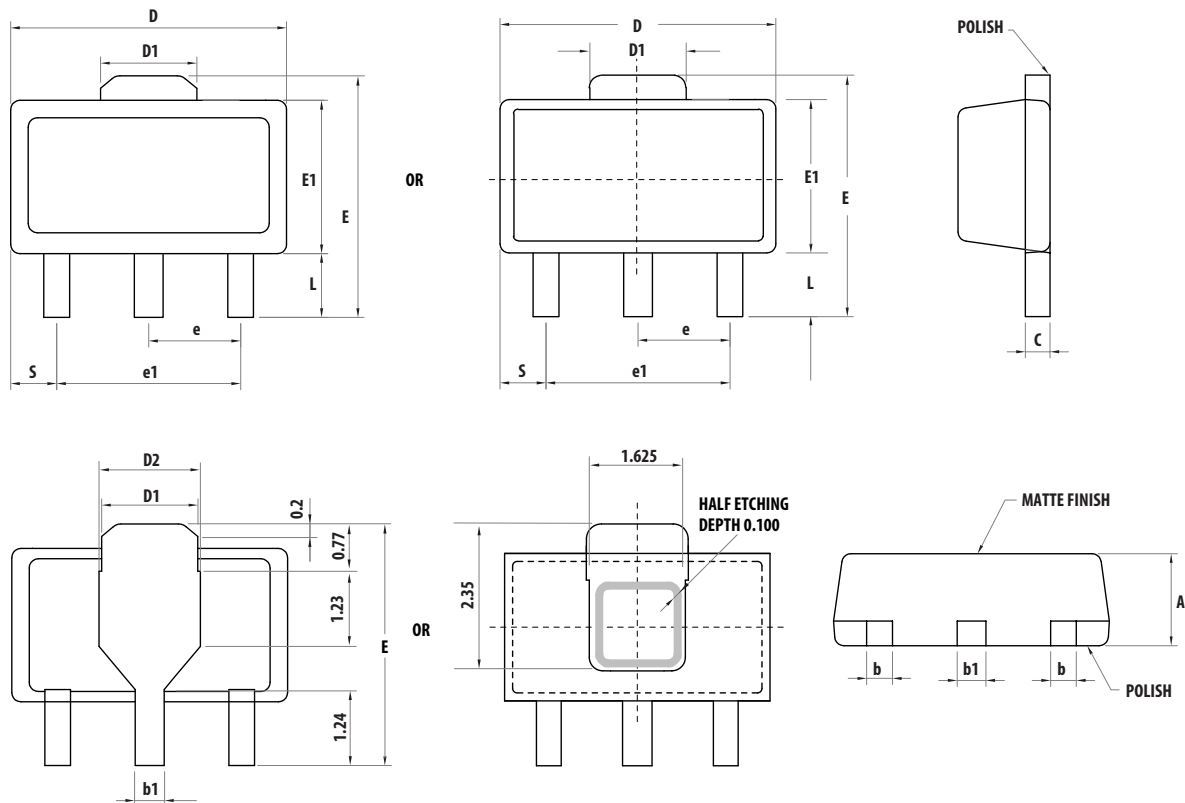

| Symbols | Dimensions in mm |         |         | Dimensions in inches |         |         |
|---------|------------------|---------|---------|----------------------|---------|---------|
|         | Minimum          | Nominal | Maximum | Minimum              | Nominal | Maximum |
| A       | 1.40             | 1.50    | 1.60    | 0.055                | 0.059   | 0.063   |
| L       | 0.89             | 1.04    | 1.20    | 0.0350               | 0.041   | 0.047   |
| b       | 0.36             | 0.42    | 0.48    | 0.014                | 0.016   | 0.018   |
| b1      | 0.41             | 0.47    | 0.53    | 0.016                | 0.018   | 0.030   |
| C       | 0.38             | 0.40    | 0.43    | 0.014                | 0.015   | 0.017   |
| D       | 4.40             | 4.50    | 4.60    | 0.173                | 0.177   | 0.181   |
| D1      | 1.40             | 1.60    | 1.75    | 0.055                | 0.062   | 0.069   |
| D2      | 1.45             | 1.65    | 1.80    | 0.055                | 0.062   | 0.069   |
| E       | 3.94             | -       | 4.25    | 0.155                | -       | 0.167   |
| E1      | 2.40             | 2.50    | 2.60    | 0.094                | 0.098   | 0.102   |
| e1      | 2.90             | 3.00    | 3.10    | 0.114                | 0.118   | 0.122   |
| S       | 0.65             | 0.75    | 0.85    | 0.026                | 0.030   | 0.034   |
| e       | 1.40             | 1.50    | 1.60    | 0.054                | 0.059   | 0.063   |

## Device Orientation

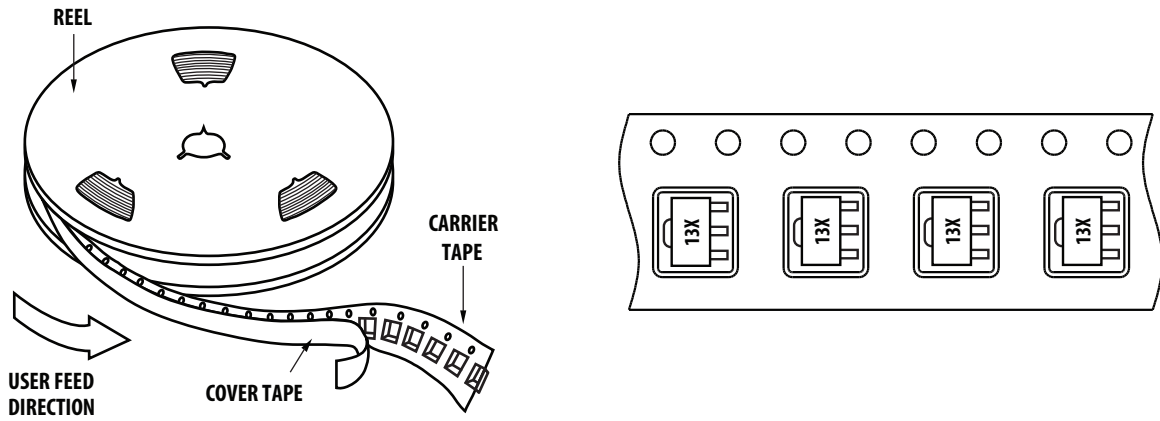

## Tape Dimensions

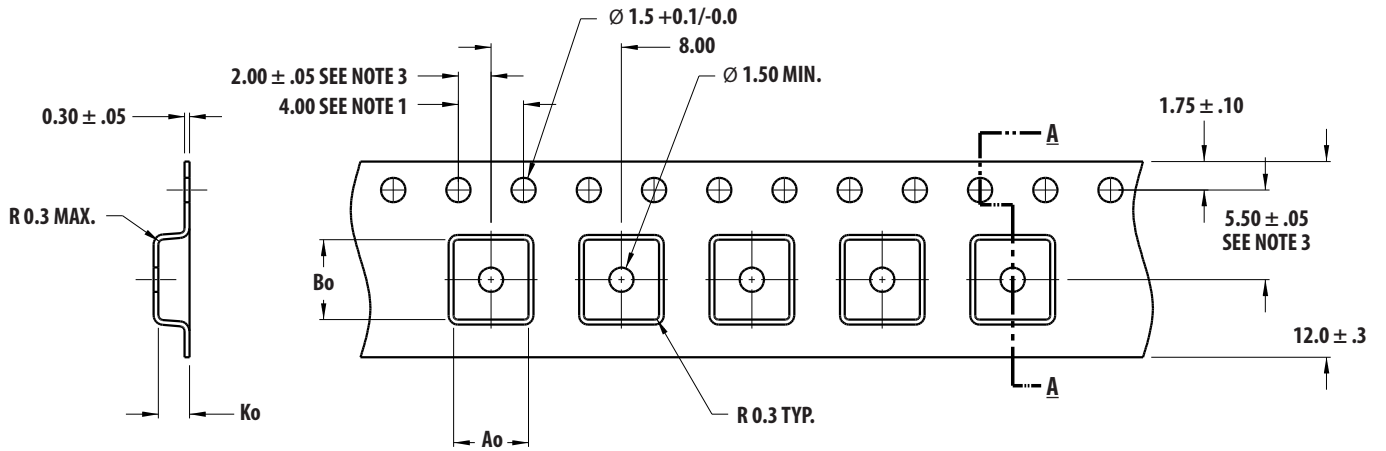

### SECTION A - A

Ao = 4.60  
Bo = 4.90  
Ko = 1.90

### DIMENSIONS IN MM

#### NOTES:

1. 10 SPROCKET HOLE PITCH CUMULATIVE TOLERANCE  $\pm 0.2$
2. CAMBER IN COMPLIANCE WITH EIA 481
3. POCKET POSITION RELATIVE TO SPROCKET HOLE MEASURED AS TRUE POSITION OF POCKET, NOT POCKET HOLE

# Reel Dimensions – 13" Reel

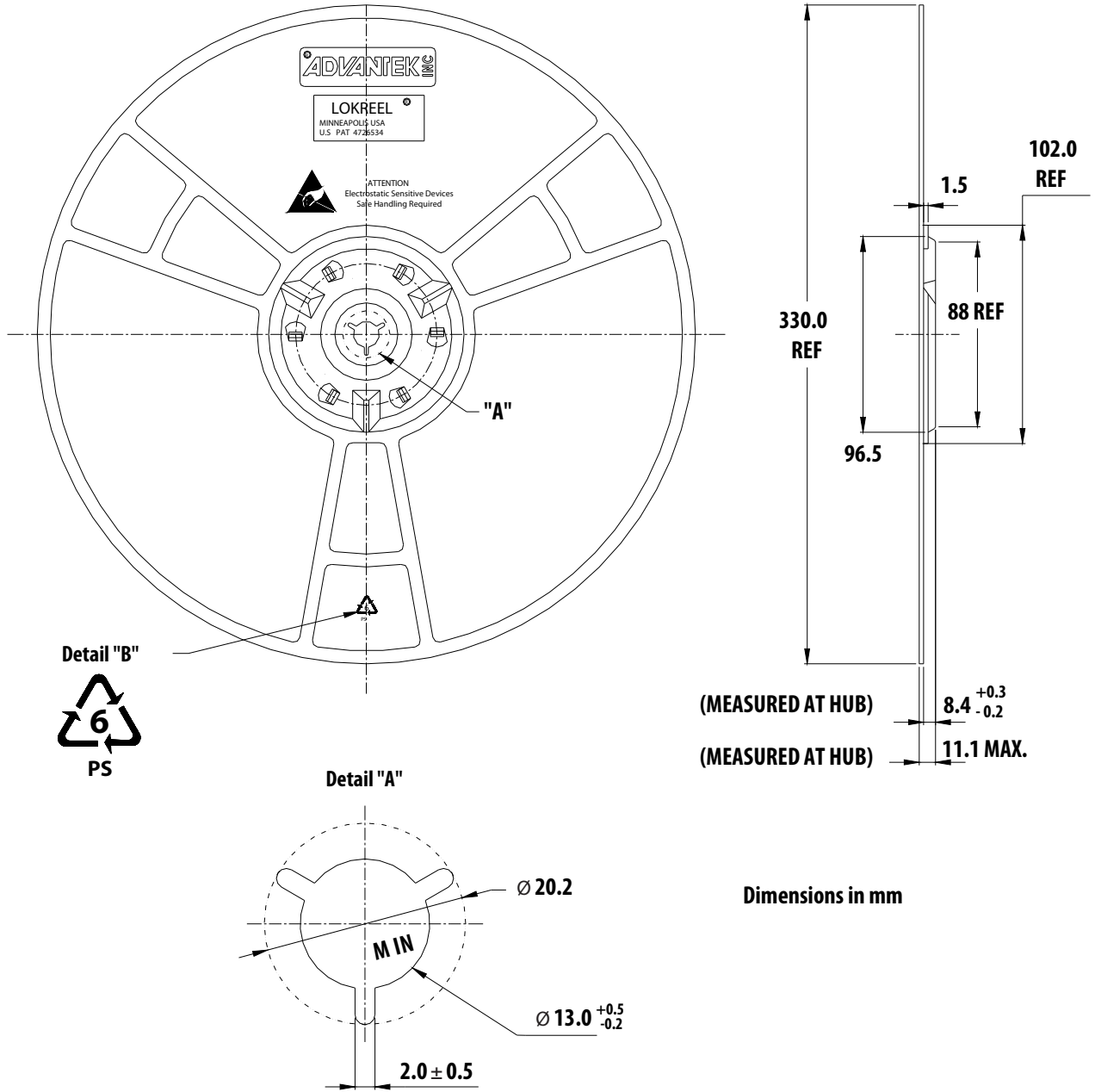

Dimensions in mm

For product information and a complete list of distributors, please go to our web site: [www.avagotech.com](http://www.avagotech.com)

Avago, Avago Technologies, and the A logo are trademarks of Avago Technologies in the United States and other countries. Data subject to change. Copyright © 2005-2013 Avago Technologies. All rights reserved. AV02-2586EN - November 11, 2013

